

ZA.4105.MTR

APPL. FRONTALE
FACE FIXING

BIG 5X5

DOPPIA GUIDA
TELESCOPICA
REGOLABILE IN
ALTO ED IN BASSO
(BREVETTO).
TELO CON BORDI
TERMOISOLANTI E
BORCHIATO.

TOP AND BOTTOM
ADJUSTABLE TELESCOPIC
SIDE GUIDES - PATENTED -
HEAT-SEALED FABRIC
EDGES, COMPLETE WITH
METAL STUDS.

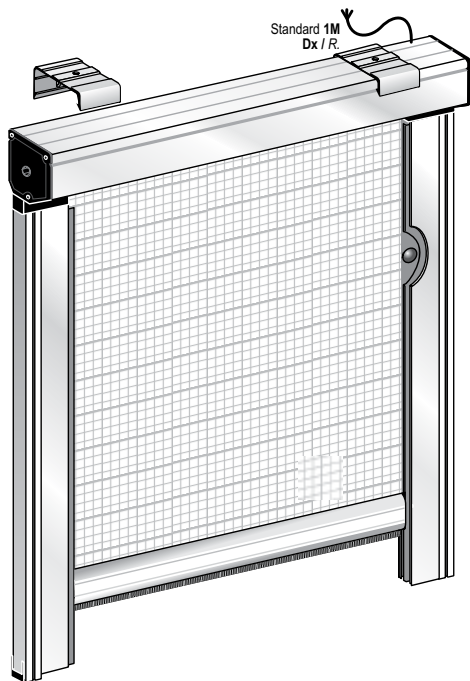

ALUMINIUM

Aumento prezzo / Price increase

001 Anodizz. Argento Natural Anodized STANDARD	---
002 Anodizz. Bronzo Bronze Anodized	---
005 Bronzo Rossiccio Red Bronze Anodized	+4%
006 Elettrocol. T. di Moro Dark Brown Anodized	+4%
201 - RAL 9010 Bianco Lucido Gloss white coated	+2%
200 - RAL 1013 Panna Lucido Gloss cream coated	+2%
203 - RAL 8017 Marrone Gloss brown coated	+4%
211 - RAL 6005 Verde Gloss green coated	+4%
215-220 Effetto LEGNO Wood finishing	+20%
999 - RAL a scelta: Chiedere sempre tempi di consegna! Other colours Ask delivery time!	+15% +100 € Nette, fisse. NET

PLASTIC

All. BIANCO e PANNA White/Cream aluminium	BIANCHI White
Tutti altri colori allum. All other aluminium colours	NERI Black
All. RAL: definire colore nell'ordine. Ral Alum.: specify plastic colour	

OPTIONALS

INVERTITORE MOMENTANEO

60072	
+ 18,3€	Cad. Each

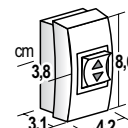

MOTORE STAR con RICEVENTE MOTOR WITH RECEIVER INCLUDED AND REMOTE CONTROLS

MN 0035	+ 120,0 €	Cad. Each
Radioc. 1 can.	60543	+ 60,0 € Cad. Each
Radioc. 5 can.	60544	+ 75,0 € Cad. Each

RADIOCOMANDI AUTOMATISMI CENTRALINE

Pag. 282
REMOTE CONTROLS, CENTRAL CONTROL UNITS

MOTORE STAR con FINECORSIA ELETTRONICO per DOMOTICA

Attenzione: verificare la compatibilità!
ELECTRONIC LIMIT SWITCH MOTOR, «HOME AUTOMATION»
COMPATIBLE (Please check your system compatibility).

MONTANTE

Per affiancare più tende

20056 + 20057	
+ 26,5 €	m ² / Im.

UPRIGHT For joined blinds

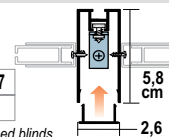

STAFFE - BRACKETS

70166	
+ 11,0 €	2 PZ. / 2 PCS



RICAMO AD ALTA PERCEZIONE

Per evitare lo sfondamento della rete o per decorare.

MN053	
+ 28 €	m ² L. m.
	min 1,2 m

High perception embroidery to avoid breaching the fabric.

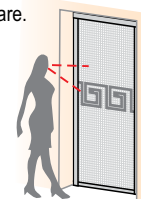

SPRAY MANGIA-SMOG

Depura l'aria dallo smog grazie all'azione del biossido di Titanio. 1 Bomboletta è idonea per 2-3 mq di tessuto. (Per grandi quantità contattate i nostri uffici)

70834	+ 180,0 €
-------	-----------

6 SPRAY con display



ANTI-SMOG AIR PURIFIER SPRAY

Purify the air thanks to action of titanium dioxide. 1 Spray is suitable for 2-3 sqm of fabric. Ask to our offices more details for big quantities.

TESSUTO:

Codice 10880 Grigio Tessuto in fibra di vetro ricoperta da PVC autoestinguento, perfettamente lavabile.

FABRIC: Code 10880. Grey PVC coated fiberglass self extinguishing, washable.

MODULO ORDINE:

Ordini veloci e completi con l'apposito modulo che trovi in fondo al capitolo o sul sito web.

ORDER FORM: Use the order form at the end of chapter or on the web site.

Suncover si riserva la facoltà di modificare/adeguare le informazioni tecniche e le caratteristiche dei prodotti, anche senza preavviso alcuno.

Suncover reserves the right to change specifications and characteristics of the products without any notice.

! DATI MOTORE PAG. 282
Electric Motor Details

CL.3: Max resistenza al vento Class 3 (top class wind resistance)

CE EN 13561

10 ANNI GARANZIA

MOTORE ALIMENTATO A BATTERIE RICARICABILI CON PANNELLO SOLARE

È possibile ricaricare le batterie anche con rete 220V. Installazione facile, veloce ed economica!

MN 0055	Motore + Batteria LITIO + caricabatteria con spina Motor + Lithium Battery+charger/plug	+ 310,0 €
60597	Pannello Solare Solar Panel	+ 60,0 €
60592	Radio-comando per 1 tenda Remote control for 1 blind	+ 55,0 €
60593	Radio-comando fino a 5 tende Remote control for up to 5 blinds	+ 70,0 €

Battery motor rechargeable with a solar panel. It's possible to charge the battery also with 220V plug. Easy, quick and inexpensive installation!



ZA.4106.MTR

+ 9,4 € / m²

BANCALE IN ALLUMINIO ALUMINIUM SILL

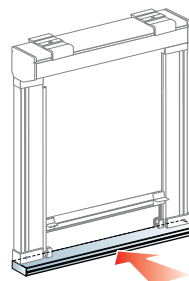

Cass 80 e 105: con colori LEGNO chiedere tempi di consegna.

Wooden colours for Cassettes 80-105: please, ask delivery time.

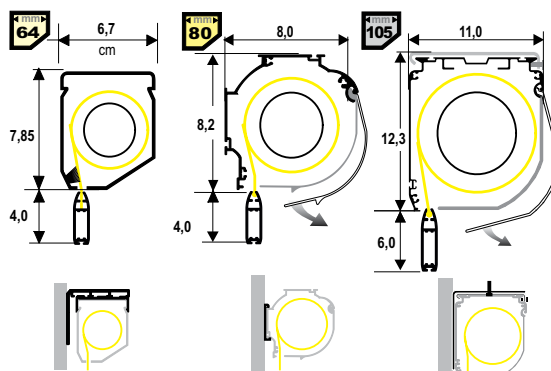
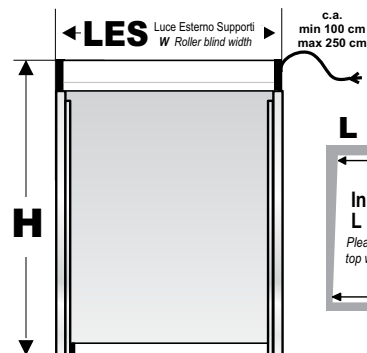

Standard: Uscita cavo 1M - DESTRO.

Oppure indicare sull'ordine lato e posizione desiderati.

STANDARD: Motor at the R.H side - 1M (unless otherwise stated)

- 1M Applicaz. a soffitto Top fixing
- 2M Applicaz. frontale Face fixing
- 3M A richiesta solo con cass 64 On request only with 64 cass
- 4M Uscita laterale del cavo Side cable exit

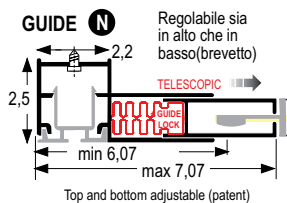

BANCALE SILL

