

SO.2015.AST

TENDA COMPLETA DI PORTARULLO IN ALLUMINIO PER UN FACILE MONTAGGIO IN SICUREZZA.

STAFFE IN ACCIAIO COPERTE DA CUFFIE ANTIURTO.

CAVI GUIDA IN ACCIAIO INOX PIOMBATI - Ø 3 MM.

FONDALE BASCULANTE.

BLIND WITH ALUMINIUM TUBE HOLDER FOR EASY AND FAST INSTALLATIONS. STEEL BRACKETS + COVER PLATES. STAINLESS STEEL SIDE CABLES Ø 3 MM. SELF-STABILIZING BOTTOM RAIL

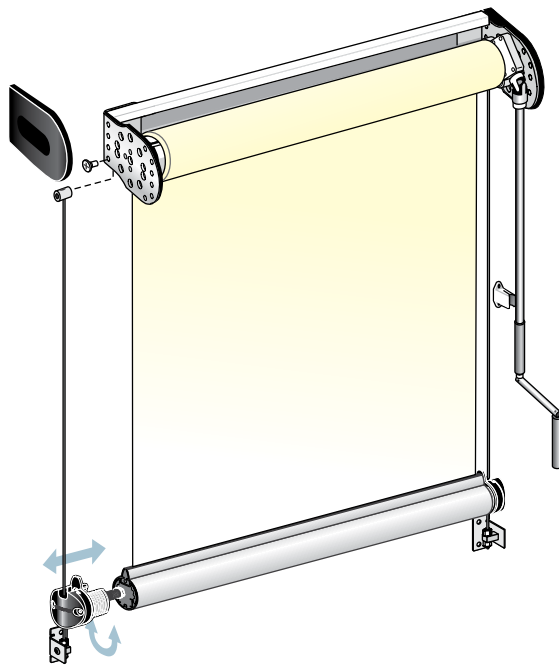

APPLICAZ. ASTA PAG. 280
Hand crank details

ALUMINIUM

Aumento prezzo / Price increase

001 - Anodizzato Argento Natural Anodized - STANDARD	---
002 - Anodizzato Bronzo Bronze Anodized	---
006 - Electr. Testa di Moro Dark brown Anodized	+5%
201 - RAL 9010 Bianco Lucido Gloss white coated	+3%
200 - RAL 1013 Panna Lucido Gloss cream coated	+3%
999 - RAL a scelta: Attenzione! richiedere sempre tempi di consegna! Other colours: ask for delivery time!	+18% +100 € Nette, fisse, NET

PLASTIC

All. BIANCO e PANNA White/Cream aluminium	BIANCHI White
Tutti altri colori allum. All other aluminium colours	NERI Black
All. RAL: definire colore nell'ordine. Ral Alum.: specify plastic colour	

MANOVELLA / HANDLE

Alluminio Bianco Panna White Cream Aluminium	BIANCA White
Alluminio Argento Natural Aluminium	GRIGIA Grey
Tutti altri colori alluminio All other alum. colours	NERA Black



Esterno solo con: Outdoor only with:
MICROSCREEN - VETROSCREEN
TEKNOSCREEN - SUNCOVERSCREEN
BLACKOUT10 - VETROBLACKOUT

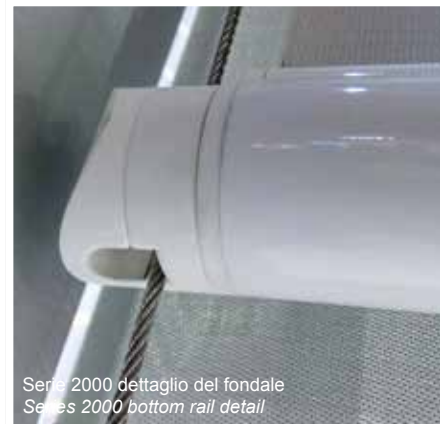

Serie 2000 dettaglio del fondale
Series 2000 bottom rail detail

ALTERNATIVES

SO.2033.AST

+18 € cad.
each

VEDI CODICI PAG. 280
CODES PAGE 280

+ 35,0 €

ASTA ASPORTABILE

Ideale in ambienti pubblici.
Richiedere ulteriori info presso nostri uffici.

REMOVABLE HANDLE: suitable for public areas. Contact our sales office for more details

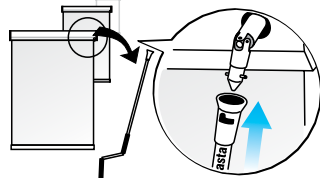

RINVIO ASTA 45° / 90°

Ulteriori informazioni tecniche e commerciali capitolo «Dati Tecnici» ed in sede

Angle drive 45° / 90°. Further details: see last chapter «Technical Details» or contact us

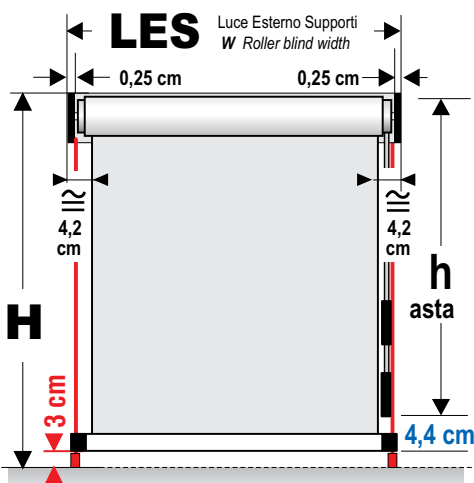
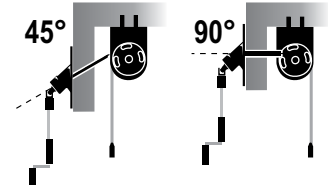

Standard: Lato comando DESTRO.

Indicare sull'ordine lato e posizione desiderati.

L'asta è consigliata a 120 cm. da terra.

STANDARD: handle at the R.H side (unless otherwise stated)
We recommend a distance from the floor of 120 cm..

Attacco Frontale
Face fixing

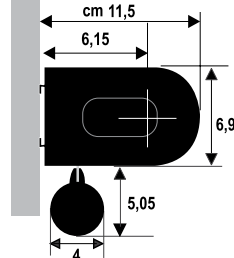

Supporto in acciaio + cuffia
Steel bracket + Cover plate

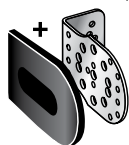

Attacco a soffitto
Top fixing

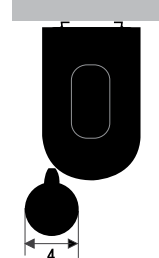

Innesto rapido
Quick hitch

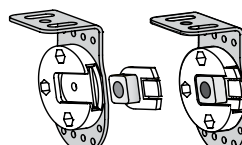

CODICI TESSUTO:

Campionario **TECHNOCOLOURS**
Vista **INTERNA**: tessuto così come mostrato nel campionario.
TESSUTO GIRATO: scegliere TR sul modulo d'ordine.

FABRIC: see **TECHNOCOLOURS** collection. Fabric is intended viewing from inside. Back side fabric: cross BS on the form.

MODULO ORDINE:

Ordini veloci e completi con l'apposito modulo che trovi in fondo al capitolo o sul sito web.

ORDER FORM:

Use the order form at the end of chapter or on the web site.

Suncover si riserva la facoltà di modificare/adeguare le informazioni tecniche e le caratteristiche dei prodotti, anche senza preavviso alcuno.

Suncover reserves the right to change specifications and characteristics of the products without any notice.