

## OS.4015.CTF

APPL. SOFFITTO  
TOP FIXING

DOPPIA GUIDA  
TELESCOPICA  
REGOLABILE IN  
ALTO ED IN BASSO  
(BREVETTO).

TELO CON BORDI  
TERMOISOLANTI E  
BORCHIATI.

SUPPORTI IDONEI  
PER TENDE DI  
GRANDI DIMENSIONI  
CON COMANDO A  
CATENELLA.

TOP AND BOTTOM  
ADJUSTABLE TELESCOPIC  
SIDE GUIDES - PATENTED -  
HEAT-SEALED FABRIC  
EDGES, COMPLETE WITH  
METAL STUDS.  
SUITABLE BRACKETS FOR  
BIG DIMENSIONS ROLLER  
BLINDS WITH CHAIN OP.  
SYSTEM.

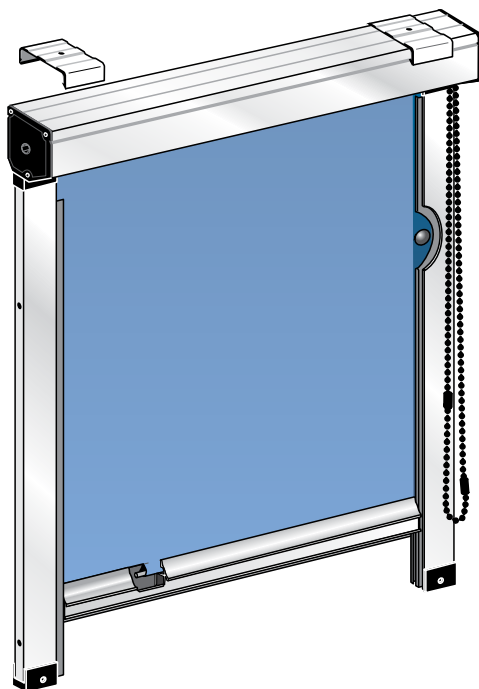

### ALUMINIUM

Aumento prezzo / Price increase

001 - Anodizzato Argento Natural Anodized - STANDARD	---
002 - Anodizzato Bronzo Bronze Anodized	---
006 - Elettr. Testa di Moro Dark brown Anodized	+12%
201 - RAL 9010 Bianco Lucido Gloss white coated	+9%
200 - RAL 1013 Panna Lucido Gloss cream coated	+9%
999 - RAL a scelta: Attenzione! richiedere sempre tempi di consegna! Other colours: ask for delivery time!	+25%
	+100 € Nette, fisse, NET

### PLASTIC

All. BIANCO e PANNA White/Cream aluminium	BIANCHI White
Tutti altri colori allum. All other aluminium colours	NERI Black
All. RAL: definire colore nell'ordine. Ral Alum.: specify plastic colour	

### STANDARD GUIDE

# E - M

A RICHIESTA:  
CATENELLA IN METALLO  
On request - Metal Chain



INTERNO  
INDOOR

### OPTIONALS

#### TENSORE CATENA Con molla interna

70200.210 Nero Black
70200.201 Bianco White
+ 13,0 € Cad. Each

CHAIN TENSOR (internal spring)

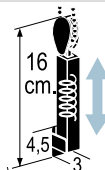

#### MONTANTE

Per affiancare  
più tende

20056 + 20057
+ 26,5 € m/l

UPRIGHT For joined blinds

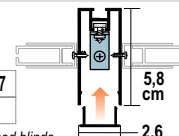

#### STAFFE - BRACKETS

70166
+ 11,0 € 2 PZ. 2 PCS



ALTERNATIVES

## OS.4017.CTF

a coppia  
each pair + 38,8 € m/l

### TENDA CON GUIDE

Per installazioni Frontali.

BLIND WITH GUIDES M  
Suitable for face applications.

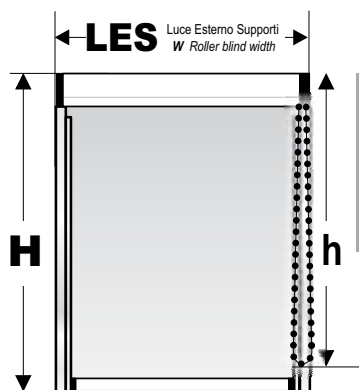
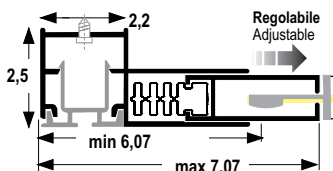

$h \cong H$

Lato standard DESTRO

In alternativa indicare sull'ordine  
Misura, Colore e Lato desiderati

Op. System at the R.H. side (unless otherwise stated)

Carico di rottura della catenella:  
di plastica 25 Kg - di metallo 9 Kg  
Chain breaking load  
Plastic chain 25 Kg - metal chain 9 Kg

$L \neq L^*$   
Indicare L in alto  
Please specify top width L only

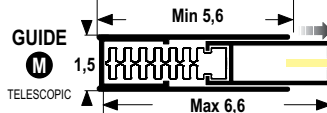
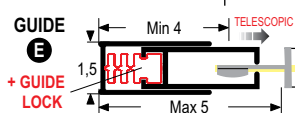
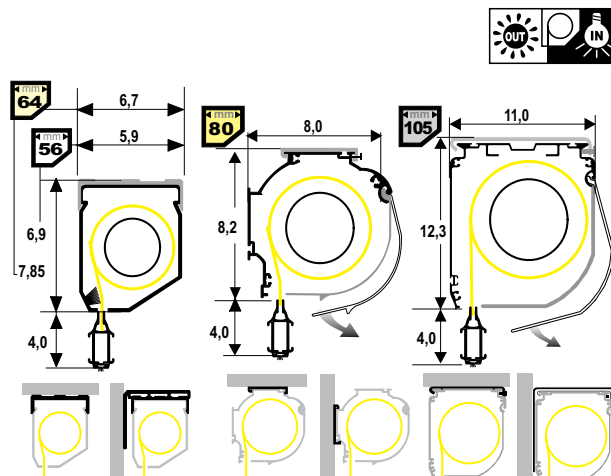

### CODICI TESSUTO:

Campionario **TECHNOCOLOURS**  
Vista INTERNA: tessuto così come  
mostrato nel campionario.  
TESSUTO GIRATO: scegliere TR sul  
modulo d'ordine.

FABRIC: see **TECHNOCOLOURS**  
collection. Fabric is intended viewing  
from inside. Back side fabric: cross  
BS on the form.

### MODULO ORDINE:

Ordini veloci e completi con l'ap-  
posito modulo che trovi in fondo al  
capitolo o sul sito web.

### ORDER FORM:

Use the order form at the end of  
chapter or on the web site.

Suncover si riserva la facoltà di  
modificare/adequare le informa-  
zioni tecniche e le caratteristi-  
che dei prodotti, anche senza  
preavviso alcuno.

Suncover reserves the right to  
change specifications and  
characteristics of the products  
without any notice.